

# Custom Passive Radiator Box Design

By 6059811B02517, 6059811B02517

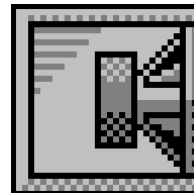

## Box Properties

--Description--

Name: SUGS-27

Type: Passive Radiator Box

Shape: Prism, square (optimum)

--Box Parameters--

Vb = 5 liters

V(total) = 5.618 liters

QL = 7

F3 = 47.76 Hz

Fill = minimal

--Passive Radiators--

No. of Passive Radiators = 1

Fs = 20.2 Hz

Qms = 1.904

Vas = 16.53 liters

Cms = 2.07 mm/N

Mms = 30 g

Rms = 2 kg/s

Sd = 74 sq.cm

## Driver Properties

--Description--

Name: W6-2253S

Type: Standard one-way driver

--Configuration--

**No. of Drivers = 1**

--Driver Parameters--

Fs = 41.4 Hz

Qms = 3.22

Vas = 6.3 liters

Xmax = 5.2 mm

Sd = 110 sq.cm

Qes = 0.6

Re = 3.6 ohms

Le = 0.185 mH

Z = 4 ohms

Pe = 50 watts



### Wiring Diagram

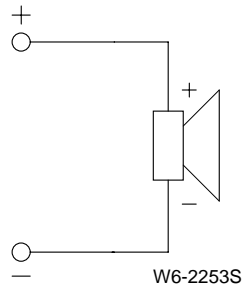

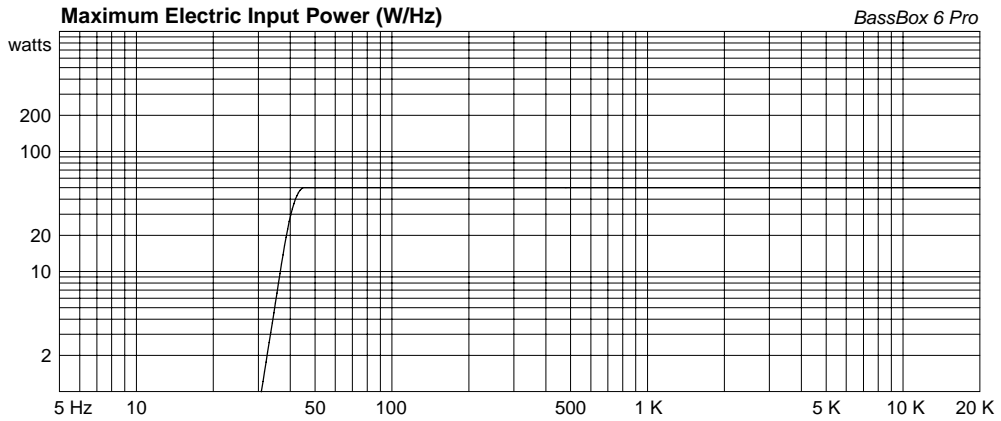
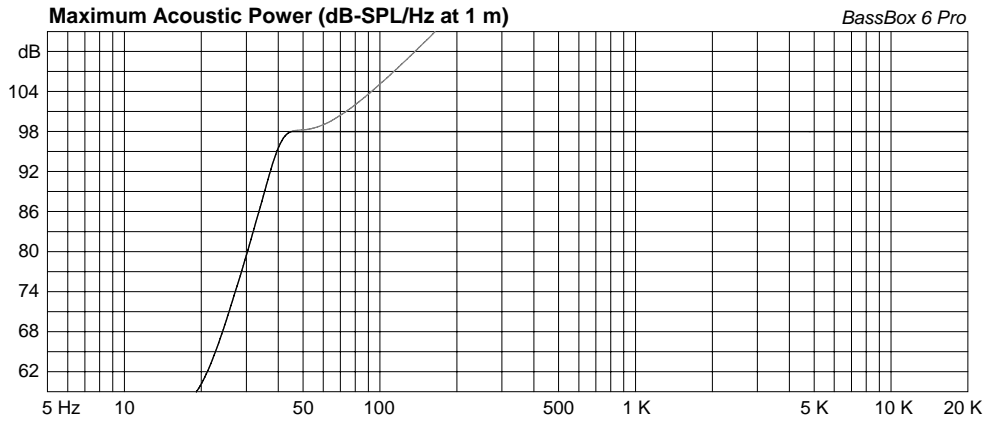
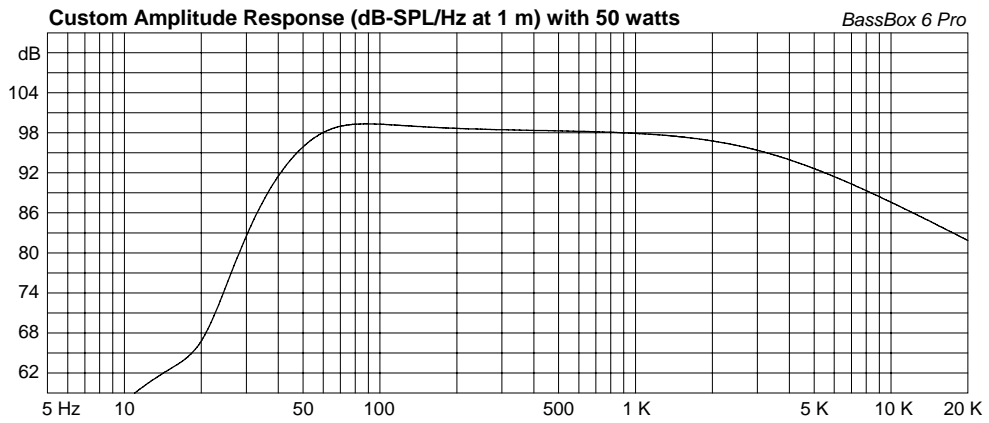
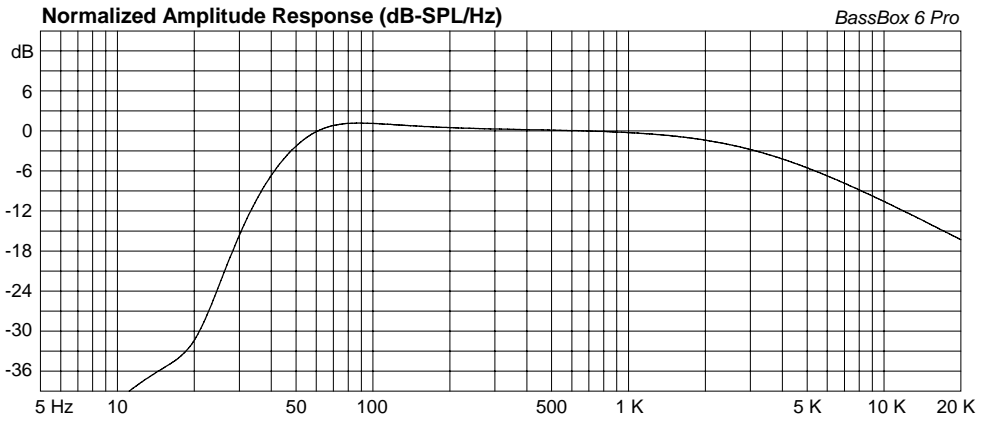

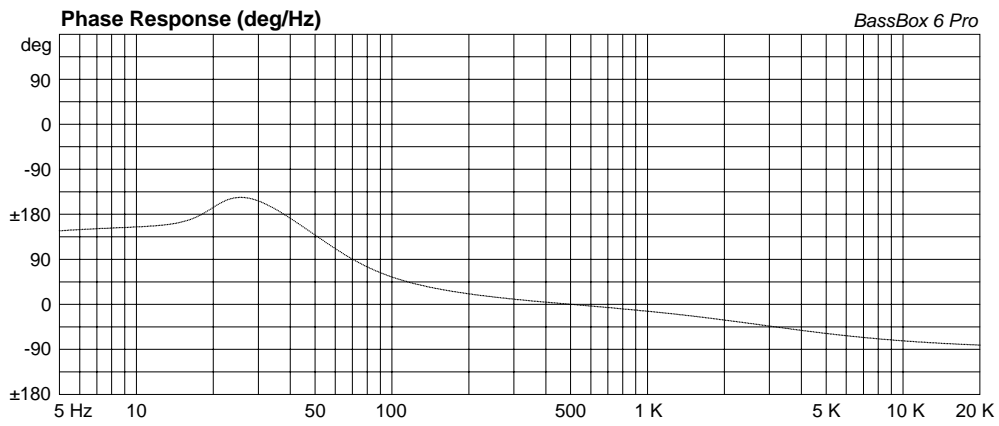
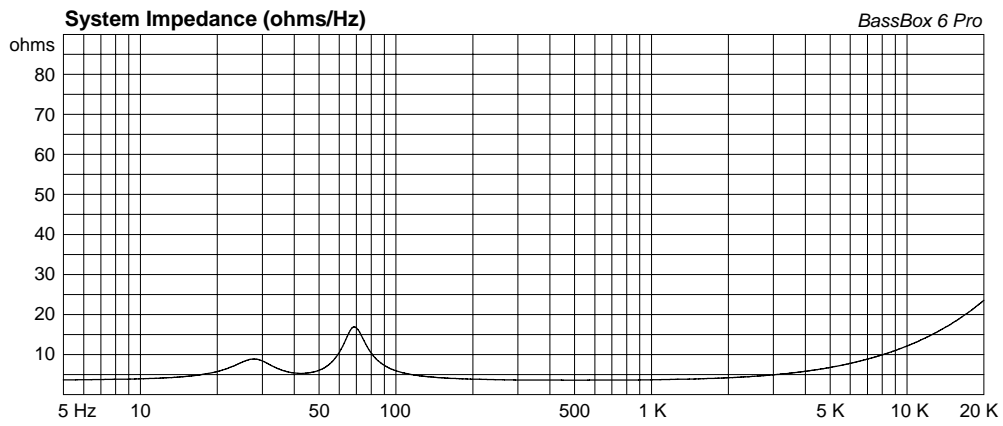
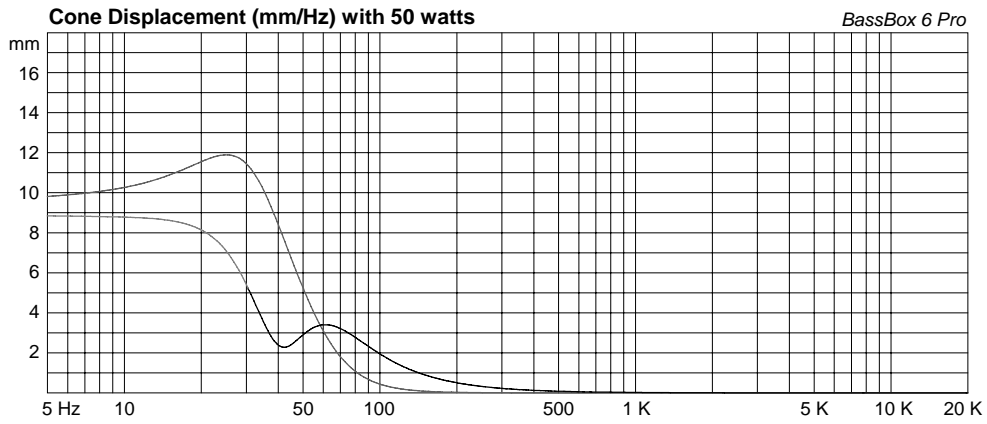

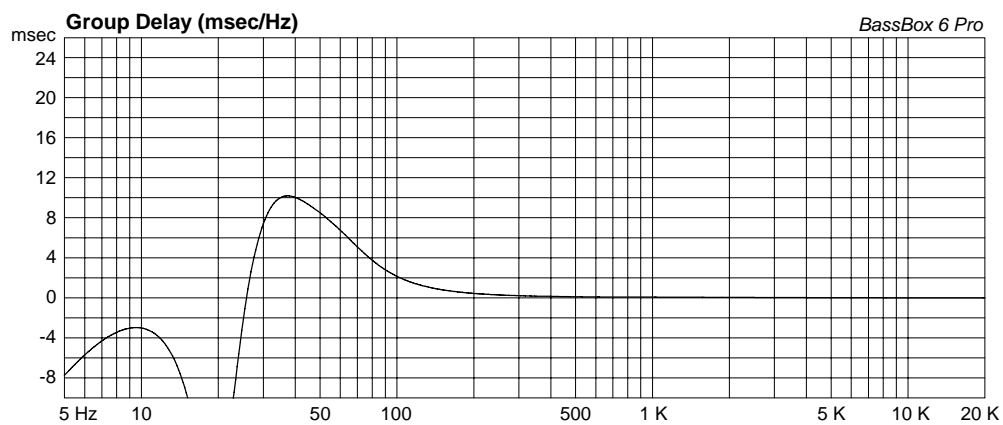

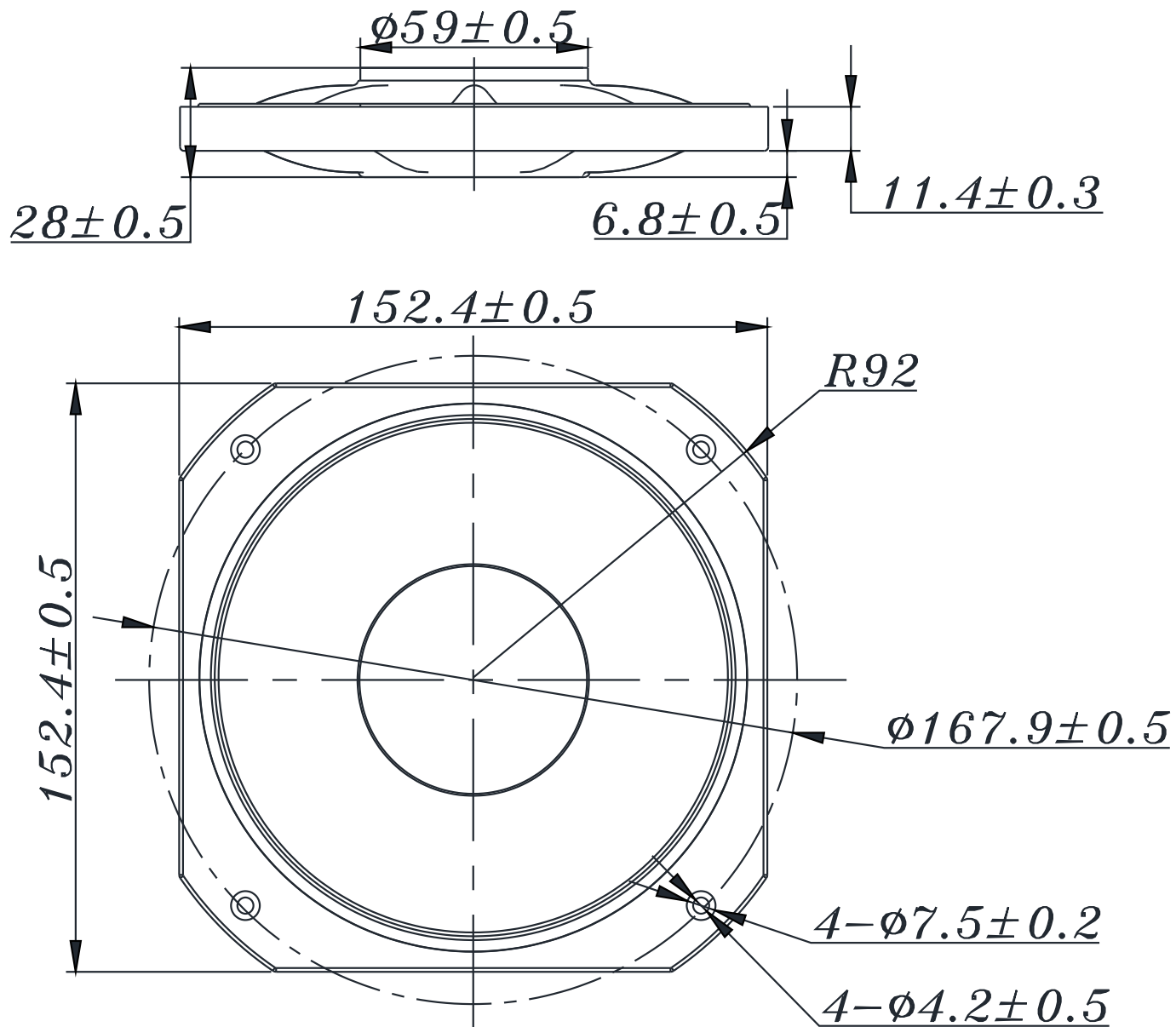

Material(材质):Rubber

**TS**  
speaker

**PR15**

Rev:R03

Date: 2020-05-20