

# Custom Passive Radiator Box Design

By CJJ, A

---

## Box Properties

--Description--

Name: W2-2040S

Type: Passive Radiator Box

Shape: Prism, square

--Box Parameters--

Vb = 0.5 liters

V(total) = 0.573 liters

QL = 7

F3 = 62.5 Hz

Fill = minimal

--Passive Radiators--

No. of Passive Radiators = 1

Fs = 13.14 Hz

Qms = 2.79

Vas = 13.51 liters

Cms = 7.339 mm/N

Mms = 20 g

Rms = 0.592 kg/s

Sd = 36 sq.cm

## Driver Properties

--Description--

Name: W2-2040S

Type: Standard one-way driver

--Configuration--

**No. of Drivers = 1**

--Driver Parameters--

Fs = 72 Hz

Qms = 5.2

Vas = 0.2 liters

Xmax = 5.3 mm

Sd = 14 sq.cm

Qes = 0.27

Re = 3.5 ohms

Le = 0.246 mH

Z = 4 ohms

Pe = 10 watts

### Wiring Diagram

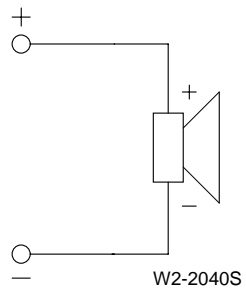

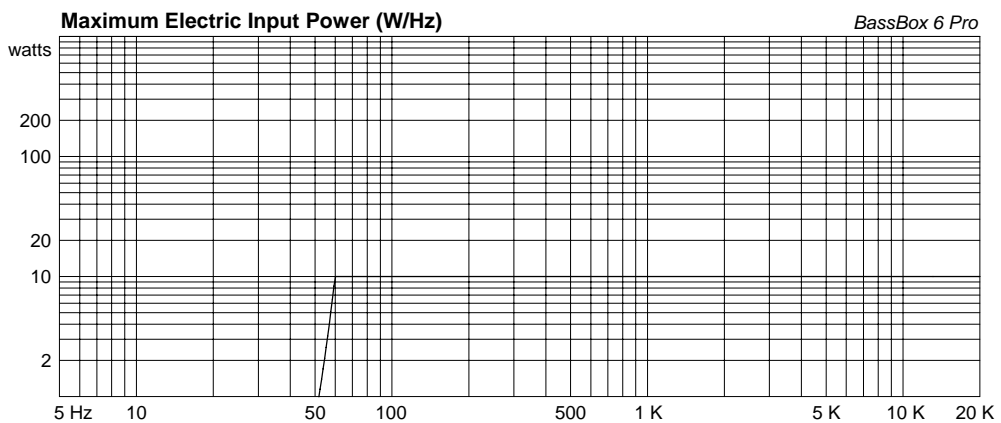
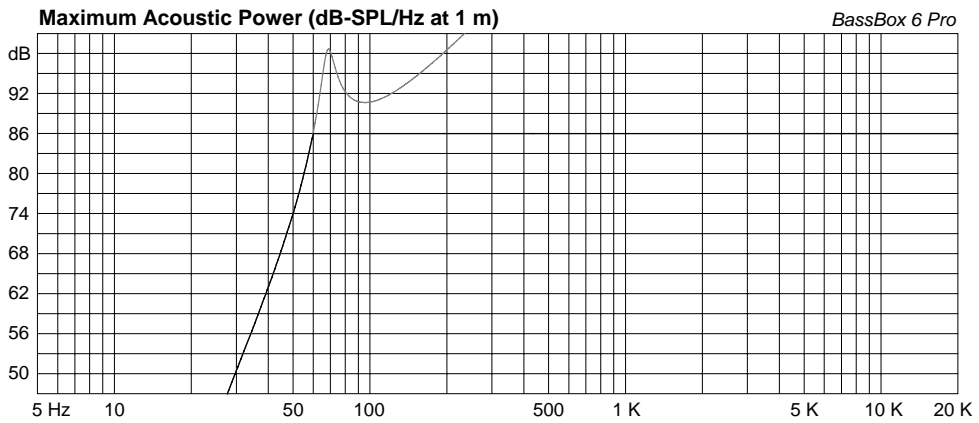
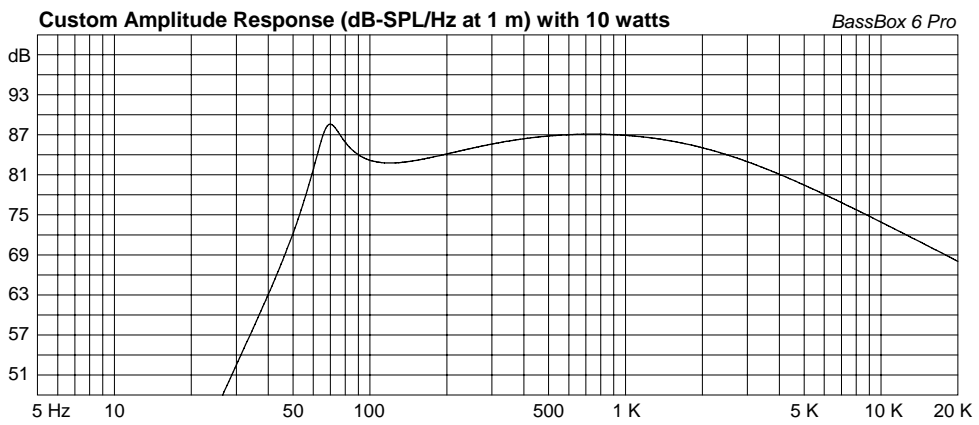
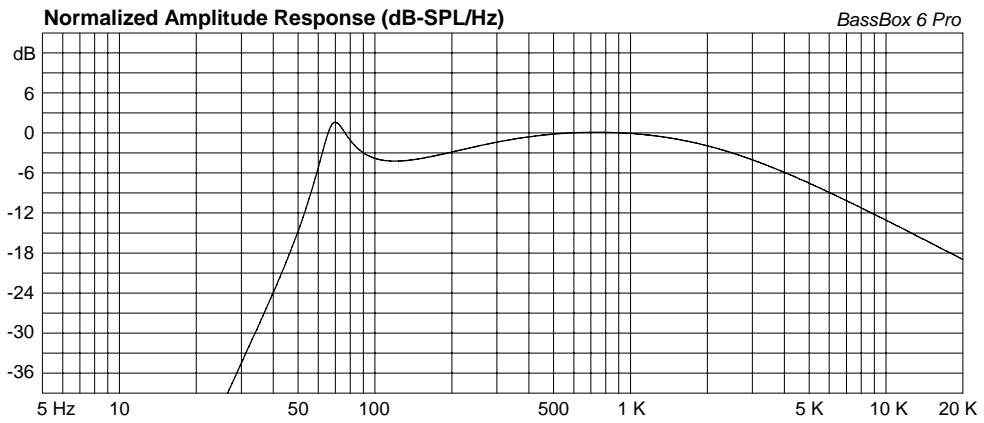

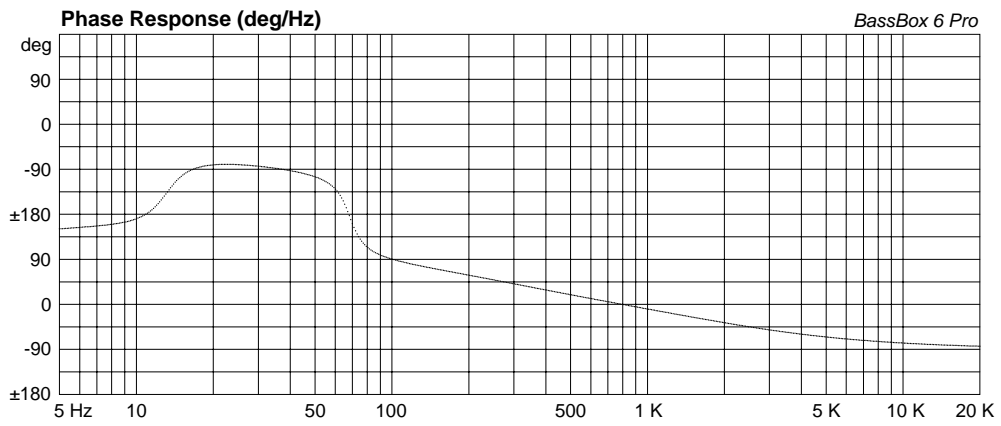
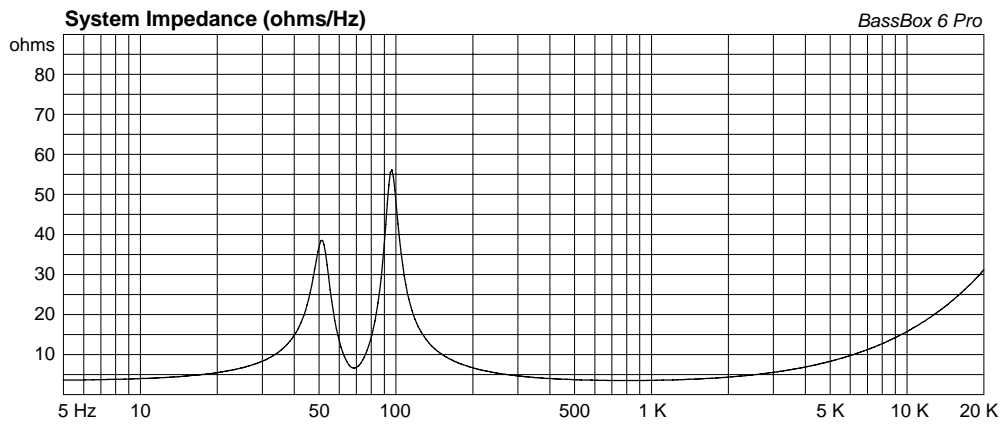
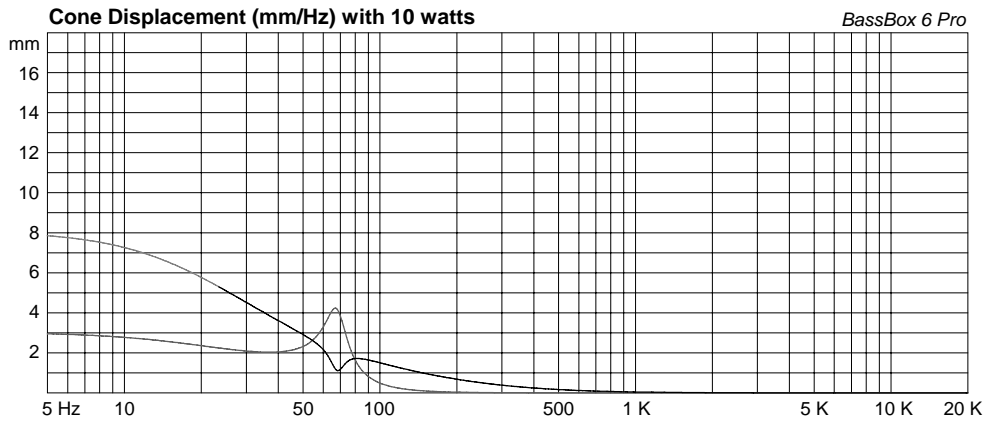

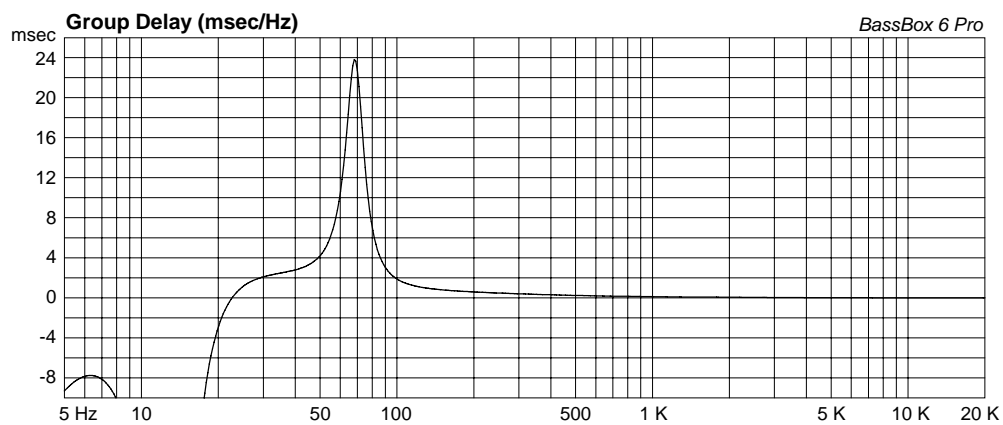

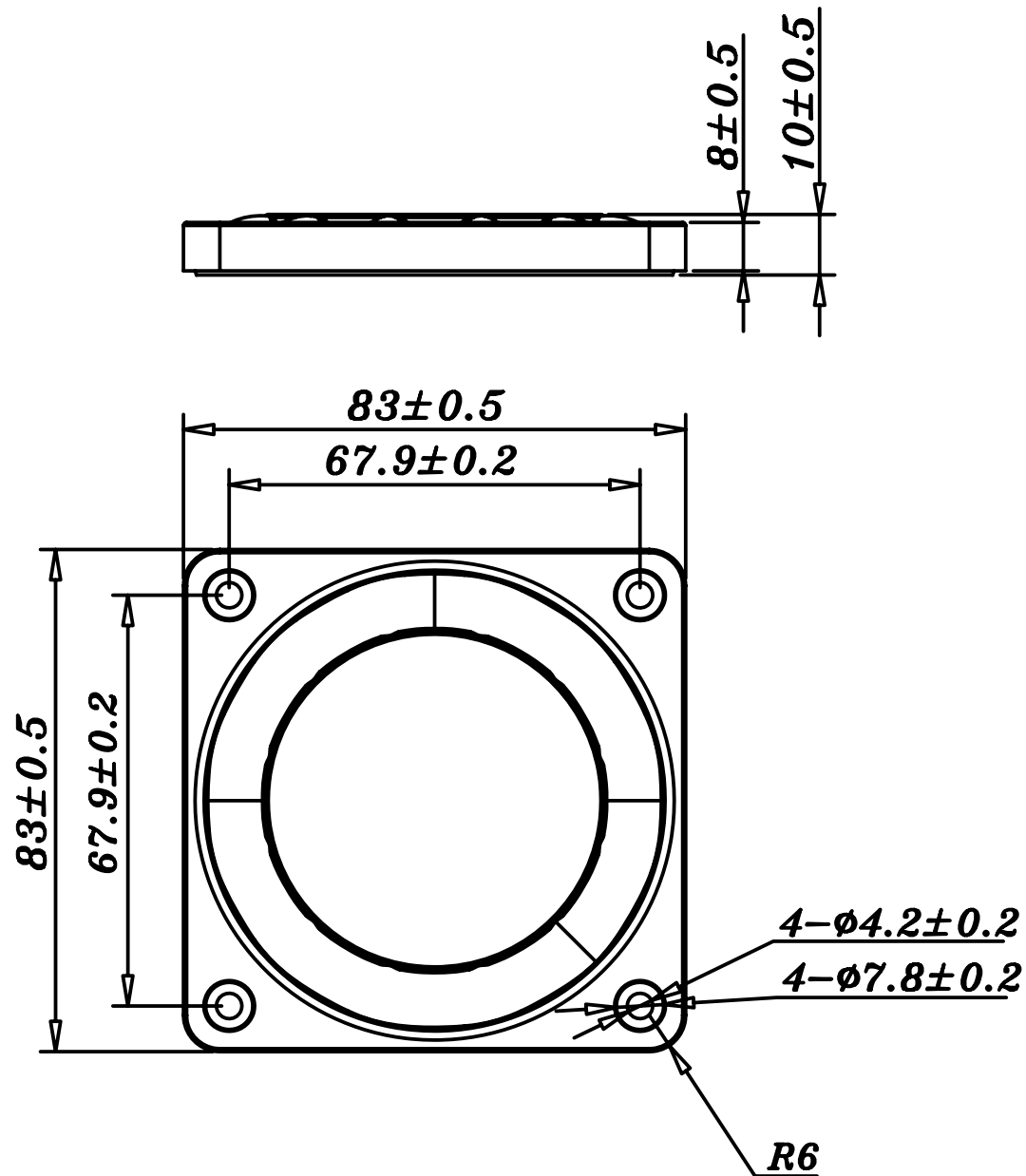

Material(材质):Rubber

**TS**  
speaker

**PR08**

Rev:R01

Date : 2015-09-07