

F SERIES

W3-2141

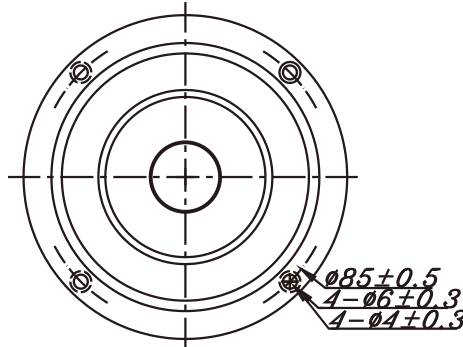
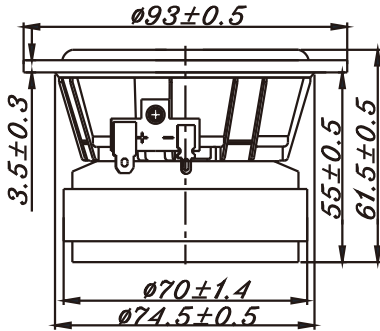

- FULL RANGE DESIGN
- UNDERHUNG MOTOR DESIGN WITH FERRITE MAGNET, $X_{max} = 1.6\text{mm}$
- VERY LOW THD (2nd AND 3rd HARMONIC DISTORTION)
- UNIQUE PHASE PLUG FOR BETTER DISPERSION
- BAMBOO FIBER PAPER CONE WITH DURABLE STRUCTURED SANTOPRENE SURROUND

3" PAPER FULL RANGE

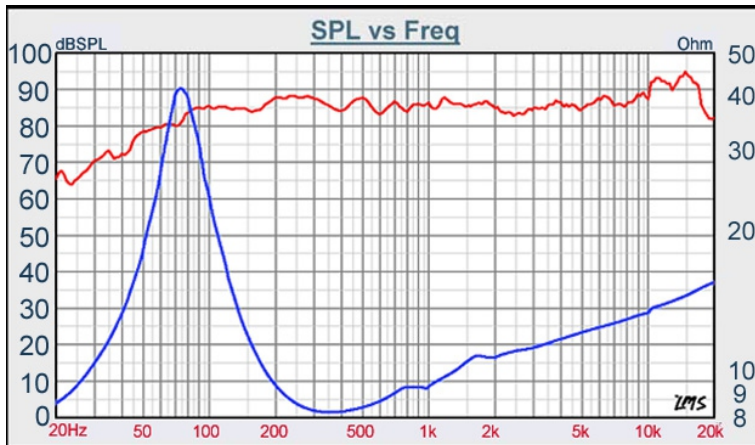

DIAPHRAGM MTL	Paper
SURROUND MTL	Structured Santoprene
NOMINAL IMPEDANCE	8 Ω
DCR IMPEDANCE	6.5 Ω
SENSITIVITY 1W/1m	87 dB
FREQUENCY RESPONSE	75 - 20K Hz
FREE AIR RESONANCE	75 Hz
VOICE COIL DIAMETER	20.4 mm
AIR GAP HEIGHT	8 mm
RATED POWER INPUT	12 W
MAXIMUM POWER INPUT	25 W
FORCE FACTOR, BL	3.64 TM
TYPE OF MAGNET	Ferrite
MOVING MASS	1.996 g
FERROFLUID ENHANCED	No
SUSPENSION COMPLIANCE	2269 μMN^{-1}
EFFECTIVE PISTON AREA	0.0032 M^2
Levc	0.020 mH
Zo	40 Ω
X-max	1.6 mm
Vas	3.30 Litr
Qts	0.39
Qms	2.51
Qes	0.46

TB SPEAKERS

VOICE: 886.2.26570282 FAX: 886.2.26580166
E-MAIL: info@tb-speaker.com