

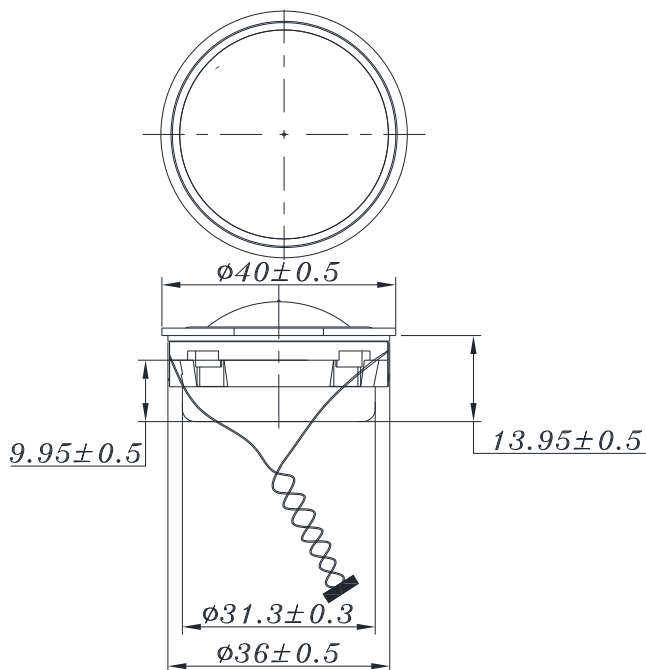

# W1-1970S

1" 铝膜 内磁式全音域喇叭

## Datasheet



DIAPHRAGM MTL	Aluminium
SURROUND MTL	Santopene
NOMINAL IMPEDANCE	4 $\Omega$
SENSITIVITY 1W/1m	78 dB
FREQUENCY RESPONSE	170 - 20 K Hz
FREE AIR RESONANCE	170 Hz
VOICE COIL DIAMETER	25.4 mm
AIR GAP HEIGHT	3 mm
RATED POWER INPUT	2 W
MAXIMUM POWER INPUT	4 W
X-max	0.6 mm

**TB**  
Speaker